

Gas Dryer Installation Instructions

**IMPORTANT:
Read and save
these instructions.**

IMPORTANT:

Installer: Leave Installation Instructions with the homeowner.

Homeowner: Keep Installation Instructions for future reference.

Save Installation Instructions for local electrical inspector's use.

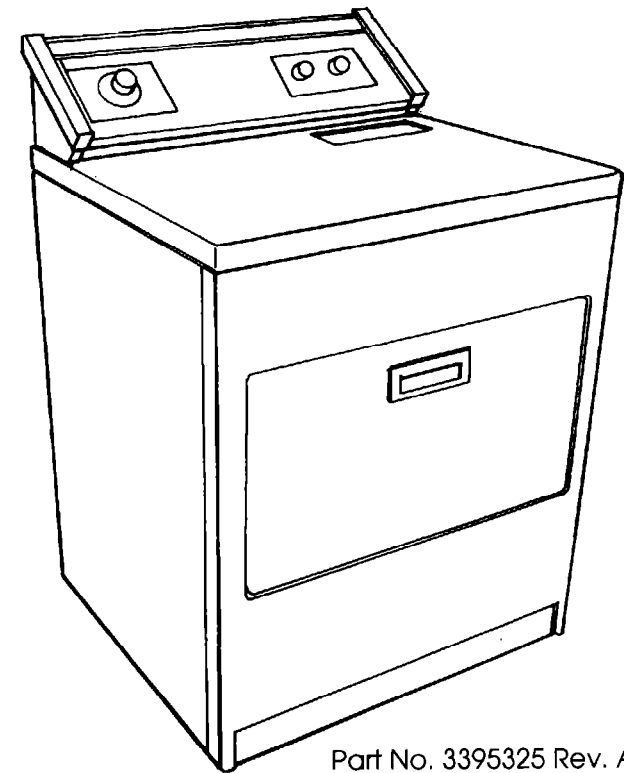

Part No. 3395325 Rev. A

3-93

Gas Dryer

Before you start...

⚠ WARNING

Fire Hazard

For your safety the information in this manual must be followed to minimize the risk of fire or explosion or to prevent property damage, personal injury or loss of life.

- Do Not store or use gasoline or other flammable vapors and liquids in the vicinity of this or any other appliance.
- WHAT TO DO IF YOU SMELL GAS
 - Do Not try to light any appliance.
 - Do Not touch any electrical switch; Do Not use any phone in your building.
 - Clear the room, building or area of all occupants.
 - Immediately call your gas supplier from a neighbor's phone. Follow the gas supplier's instructions.
 - If you cannot reach your gas supplier, call the fire department.
- Never install dryer up against draperies or curtains or on carpet.
- Keep any and all items from falling or collecting behind the dryer.

Installation and service must be performed by a qualified installer, service agency or the gas supplier.

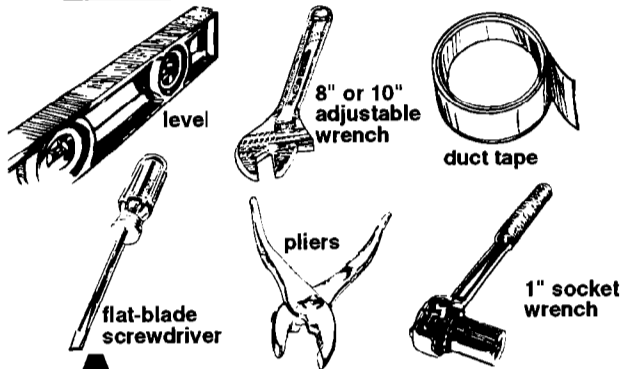

A. You need these tools to install your gas dryer. Get them together in one place to keep track of them.

B. Check the spot where you're going to install the dryer... proper installation is your responsibility. The dryer must not be installed or stored in an area where it will be exposed to water and/or weather.

C. Make sure you have everything necessary for proper installation.

- **Code requirements:** Some codes keep from or limit installation of clothes dryers in garages, closets, mobile homes and sleeping quarters. (Check with your local building inspector.)

⚠ WARNING

Fire Hazard

If you install the dryer in a garage, car port, or areas near vehicles where fumes from gasoline or other flammable materials may be present, the vapors may be heavier than air and remain near floor. Place dryer a minimum of 18 inches above floor. Check with your building inspector regarding requirements for this installation.

Failure to follow these instructions could result in fire or explosion.

Important: Observe all governing codes and ordinances.

- **Utilities:** Proper gas and electric supply connections should be available.
- **Exhaust requirements:** A four-inch metal exhaust duct is required.

LOCATION

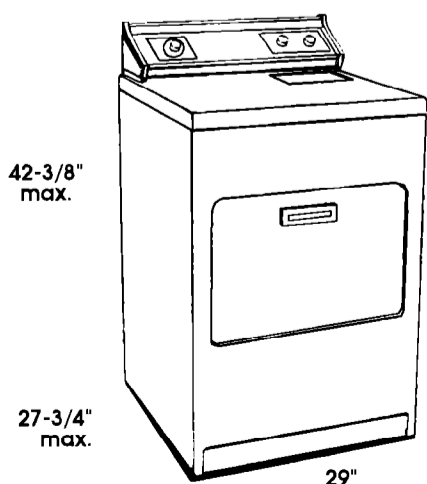

Panel A

pen dryer door. For recessed or closet installation spacing, see back cover.

Support: The floor must be able to support the appliance weight of 175 pounds.

Level floor: Maximum floor slope under dryer — 1 inch.

Protection from the weather: Proper operation of dryer cycles requires temperatures above 45°F., or the dryer may not shut off when automatic cycles are used.

This appliance is suitable for mobile home installations. The installation of the dryer must conform to the Manufactured Home Construction and Safety Standard, Title 24 CFR, Part 3280 (formerly the Federal Standard for Mobile Home Construction and Safety, Title 24, HUD, Part 280).

For mobile home use, this appliance MUST be fastened to the floor and MUST be exhausted to the outside. Order Mobile Home Installation Kit No. 346765 from your dealer. Kit includes the necessary fastening hardware and detailed installation instructions. Exhaust system hardware is also available through your dealer.

This installation must conform with American National Standard, National Fuel Gas Code ANSI Z223.1 — latest edition, and all local codes and ordinances.

Input ratings shown on the serial/rating plate are for elevations up to 2,000 feet. For elevations above 2,000 feet, ratings are reduced at a rate of 4% for each 1,000 feet of sea level.

Gas supply requirements

⚠ WARNING

Fire Hazard

- This dryer must be connected to a regulated gas supply. Failure to do so could cause high-pressure gas release, resulting in a fire or explosion.
- Have the L.P. gas checked by a qualified person before installing the dryer. The L.P. gas supply must not exceed a pressure of 13" water column.
- New flexible tubing should be used. Reusing old flexible tubing might result in possible leaks or fire hazard.

Failure to follow these instructions may result in fire or explosion.

OBSERVE ALL GOVERNING CODES AND ORDINANCES.

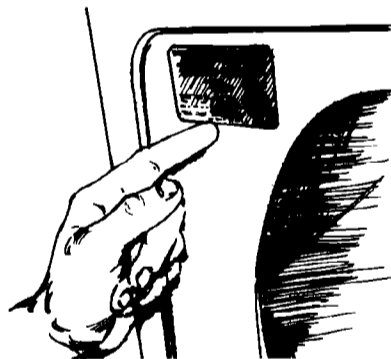

A. First make certain that this dryer is equipped with the correct burner for the particular type of gas in the home. Burner information will be found on the serial/rating plate in door well of the appliance. If this information does not agree with the type of gas available, see your dealer.

B. This dryer is equipped for use with NATURAL GAS. It is design-certified by A.G.A. for manufactured and L.P. (propane or butane) gases with appropriate conversion. No attempt shall be made to convert the appliance from the gas specified on the serial/rating plate for use with a different gas without consulting the serving gas supplier. **Conversion must be done by a qualified service technician. Gas conversion kit part numbers are listed on the gas valve burner base.**

C. Provide a rigid gas supply line to the dryer location. When rigid pipe is used it should be 1/2 inch IPS. When acceptable to the gas supplier, 3/8-inch approved tubing may be used for lengths under 20 feet. For lengths over 20 feet, larger tubing should be used. Pipe-joint compounds resistant to the action of L.P. gas must be used.

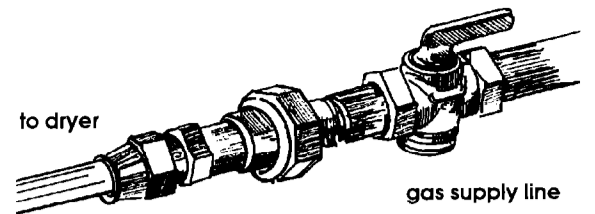

D. The supply line shall be equipped with a shutoff valve. This valve should be located in the same room as the dryer and should be in a location that allows ease of opening and closing. Do not block access to shutoff valve.

E. If the dryer is installed in a confined area such as a bedroom, bathroom or closet, provision must be made for enough air for combustion and ventilation. (Check governing codes and ordinances.) Also refer to the section of this instruction covering recessed and closet installation instructions.

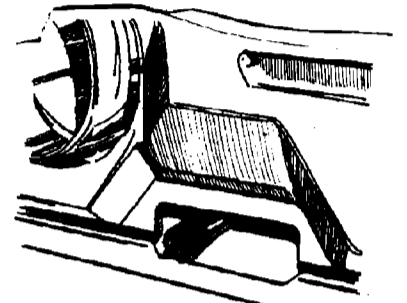

F. If local codes permit, it is recommended that new flexible metal tubing, design-certified by the American Gas Association, be used for connecting the appliance to the gas supply line. (The gas pipe which extends through the lower rear of the appliance has 3/8-inch male pipe thread.)

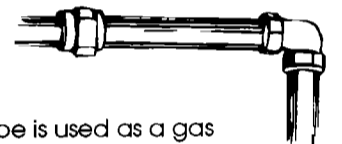

G. If rigid pipe is used as a gas supply line, a combination of pipe fittings must be used to obtain an in-line connection to the dryer.

H. Make sure that lower edges of the cabinet, plus the back and bottom sides of the dryer are free of obstructions to permit adequate clearance of air openings for combustion air. See "Recessed and closet installation instructions", on the back cover, for minimum spacing requirements.

I. For ease of installation, operating and servicing (if ever needed) adequate space should be provided around the dryer.

J. A 1/8-inch NPT plugged tapping, accessible for test gauge connection, must be installed immediately upstream of the gas supply connection to the dryer. The dryer and its individual shutoff valve must be disconnected from the gas supply piping system during any pressure testing of that system.

K. The dryer shutoff valve is located behind the front panel. The wiring diagram is located inside the console. **These items should only be accessed by a qualified service technician as follows:**

⚠ WARNING

Electrical Shock Hazard

Disconnect from electrical supply before removing front panel. Do not operate dryer without panels secured in place.

Failure to follow these instructions could result in electrical shock or death.

1. Remove lint screen and set aside.
2. Remove two screws from lint screen area.
3. Raise top by pulling forward and up at each front corner (top is hinged at rear).
4. Remove two internal screws from upper front panel flanges and lift panel off lower clips.
5. Remove door switch leads, if necessary, and set panel aside.
6. Reassemble in reverse order.

Electrical requirements

⚠ WARNING

Electrical Shock Hazard

- Electrical ground is required on this appliance.
 - If cold water pipe is interrupted by plastic, non-metallic gaskets or other insulating materials, Do Not use for grounding.
 - Do Not ground to a gas pipe.
 - Do Not modify the power supply cord plug. If it does not fit the outlet, have a proper outlet installed by a qualified electrician.
 - Do Not have a fuse in the neutral or grounding circuit. A fuse in the neutral or grounding circuit could result in an electrical shock.
 - Do Not use an extension cord with this appliance.
 - Check with a qualified electrician if you are in doubt as to whether the appliance is properly grounded.
- Failure to follow these instructions could result in serious injury or death.

If codes permit and a separate grounding wire is used, it is recommended that a qualified electrician determine that the grounding path is adequate.

A 120-volt, 60-Hz, AC-only, 15-or 20-ampere fused electrical supply is required. Time-delay fuse or circuit breaker is recommended. It is recommended that a separate circuit serving only this appliance be provided.

Recommended grounding method

For your personal safety, this appliance must be grounded. This appliance is equipped with a power supply cord having a 3-prong grounding plug. To minimize possible shock hazard, the cord must be plugged into a mating 3-prong grounding-type wall receptacle, grounded in accordance with the National Electrical Code, ANSI/NFPA 70 — latest edition, and all local codes and ordinances. If a mating wall receptacle is not available, it is the personal responsibility and obligation of the customer to have a properly grounded 3-prong wall receptacle installed by a qualified electrician.

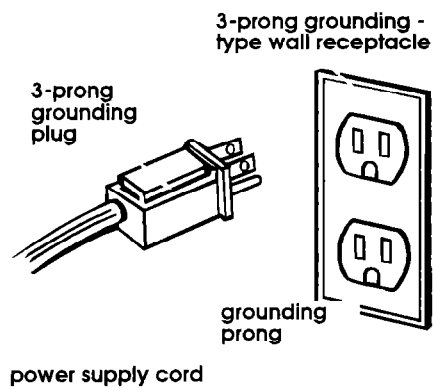

Exhaust requirements

⚠ WARNING

Fire/Health Hazard

- Do Not use non-metal, flexible duct.
 - Do Not use metal duct smaller than four inches in diameter.
 - Do Not Use exhaust hoods with magnetic latches.
 - Check that exhaust system is not longer than specified. Exhaust systems longer than specified will:
 - Accumulate lint.
 - Shorten the life of the dryer.
 - Reduce performance, resulting in longer drying times and increased energy usage.
- Failure to follow specifications may result in a fire.
- Do Not exhaust dryer into a chimney, furnace cold air duct, attic or crawl space, or any other duct used for venting.
 - Clean the exhaust system every other year.
 - Do Not install flexible duct in enclosed walls, ceilings or floors. Accumulated lint could result in a fire or cause moisture damage.
 - Exhaust the dryer outside to prevent exposure to substances in the gas fuels and combustion which may be harmful to your health.
- The moisture and lint indoors may cause:
- FIRE HAZARD from lint collected in dryer;
 - Moisture damage to woodwork, furniture, paint, wallpaper, carpet, etc.
 - House cleaning problems and possible health problems.
- Failure to follow these instructions could result in fire damage or personal injury.

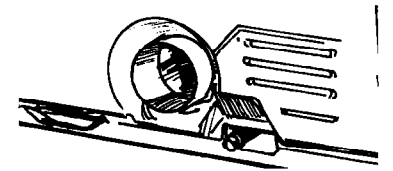

The exhaust outlet is located at the bottom center back of the dryer. Detailed space requirements can be found in the "Recessed and closet installation instructions" on the back cover and on back panel of dryer.

The maximum length of the exhaust system depends upon the type of duct used, number of elbows and type of exhaust hood. The maximum length for both rigid and flexible duct is shown in chart.

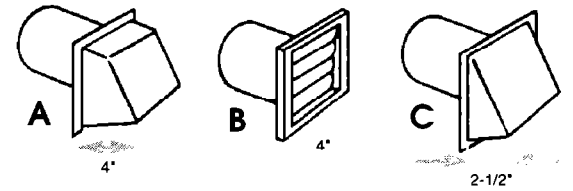

NUMBER OF 90° TURNS	EXHAUST HOOD TYPE			
	A	B	C	
0	64 FT.	64 FT.	58 FT.	MAXIMUM LENGTH OF 4" DIA. RIGID METAL DUCT
1	54 FT.	54 FT.	48 FT.	
2	44 FT.	44 FT.	38 FT.	
3	35 FT.	35 FT.	29 FT.	
4	27 FT.	27 FT.	21 FT.	
0	36 FT.	36 FT.	28 FT.	MAXIMUM LENGTH OF 4" DIA. FLEXIBLE METAL DUCT.
1	31 FT.	31 FT.	23 FT.	
2	27 FT.	27 FT.	19 FT.	
3	25 FT.	25 FT.	17 FT.	
4	23 FT.	23 FT.	15 FT.	

The maximum length using a 2" x 6" rectangular duct with 2 elbows and a 2-1/2" (TYPE C) Exhaust hood is 8 ft.

For exhaust systems not covered by the exhaust length chart, see Service Manual, Part No. 603197 available from your local parts distributor.

Service check: The back pressure in any exhaust system used must not exceed 0.6 inches of water column measured with an incline manometer at the point that the exhaust duct connects the dryer.

Use duct tape to seal all joints.

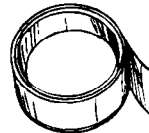

For mobile home installation, the dryer must have an outside exhaust. If you exhaust the dryer through the floor and the area under your mobile home is enclosed, the exhaust system **must** terminate outside the enclosed area. Extension beyond the enclosure will prevent lint and moisture build-up under the mobile home.

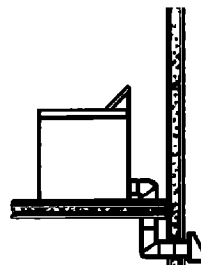

The exhaust duct can be routed up, down, left, right or straight out of the back of the dryer. Detailed space requirements can be found in "Recessed and closet installation instructions" on the back cover.

Metal flexible duct should be fully extended and supported when the dryer is in final position. DO NOT KINK OR CRUSH THE DUCT. The metal flexible duct must be completely open to allow adequate exhaust air to flow.

An exhaust hood should cap the exhaust duct to prevent exhausted air from returning into dryer. The outlet of the hood must be at least 12 inches from the ground or anything else that may be in the path of the exhaust.

4-inch outlet hood is preferred, however, a 2-1/2 inch outlet may be used with short systems only. (This outlet creates greater back pressure than other hood types.)

Now start...
with dryer in laundry area.

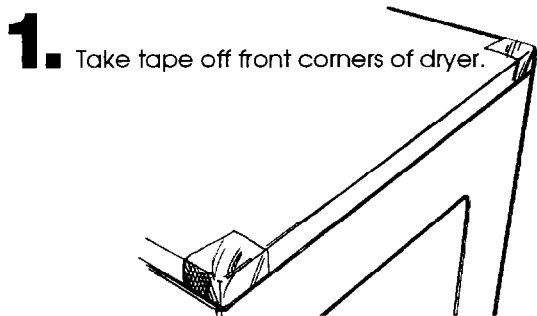

1. Take tape off front corners of dryer.

2. Open dryer and remove the literature and parts packages. (If dryer has a drying rack it should be removed also.) Remove all parts from the plastic packages. Line these up next to your tools so each part is there when you need it. Check to see that you have these parts:

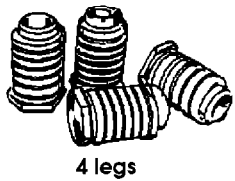

4 legs

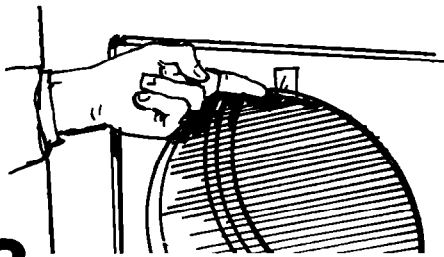

3. Remove the tape that holds the drum to the cabinet. (Some dryer drums are not taped for shipping.) Move the drum by hand to make certain all tape has been removed. Wipe the interior of the drum thoroughly with a damp cloth before using the dryer.

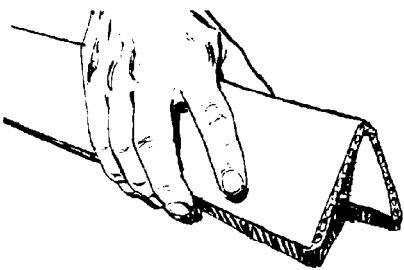

4. Take two of the cardboard corners from the carton and place them on the floor in back of the dryer.

5. Firmly grasp the body of the dryer and gently lay it on its back on the cardboard corners.

6. With one of the legs in hand, check the ridges for a diamond marking. That's how far the leg is supposed to go into the hole. Start to screw the legs into the holes by hand. A little liquid detergent to lubricate the legs will help.

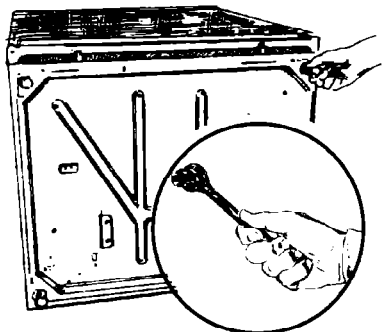
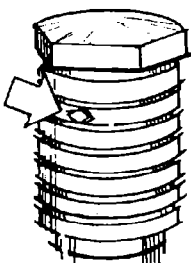

Use a 1" wrench or socket to finish turning the legs until you reach the diamond mark.

CAUTION

Floor Damage
Slide dryer onto cardboard or hardboard before moving across floor. Failure to do so may cause damage to floor covering.

7. Now stand the dryer up.

Panel C

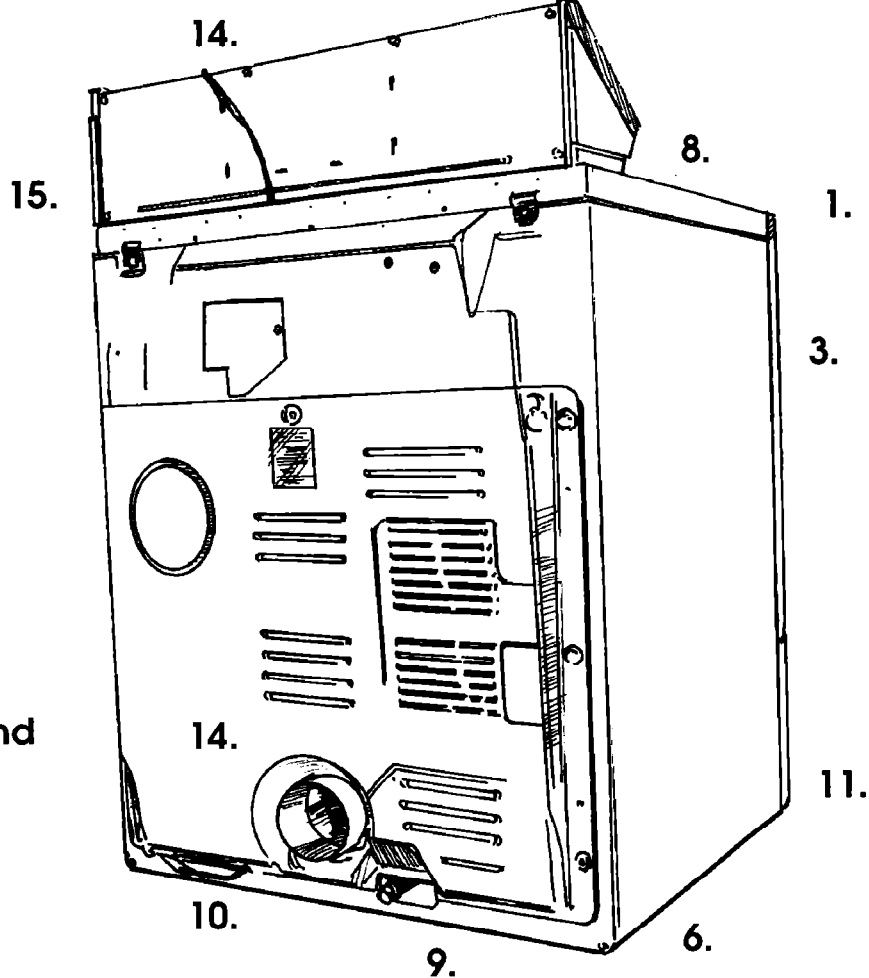

Numbers correspond to steps.

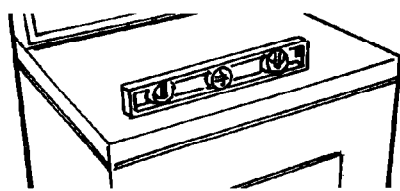

8. Move the dryer close to its final location. To make sure the dryer is level, take a carpenter's level and place it on the top of the dryer, first side to side, then front to back. If the dryer is not level, screw the legs of the dryer up or down to adjust.

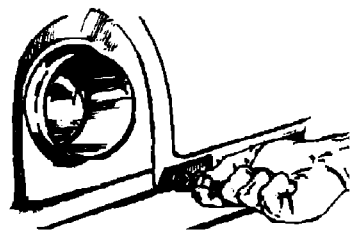

9. Remove the red cap from the gas pipe. Move the dryer into its final position.

10. Connect gas supply to dryer. Use pipe-joint compound resistant to the action of L.P. gas for gas connections. If flexible metal tubing is used, be certain there are no kinks.

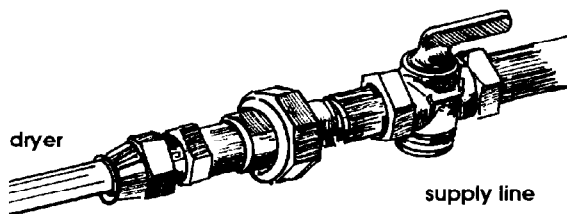

11. Open the shutoff valve in the gas supply line.

WARNING

Fire Hazard
Do Not use an open flame to test for leaks from gas connections. Checking for leaks with a flame may result in a fire or explosion.

12. Use a brush and liquid detergent to test all external gas connections for leaks. Bubbles around connections will indicate a leak. If a leak appears, shut off gas valve controls and adjust connections. Then check connections again.

13. To exhaust the dryer, see Exhaust requirements. Connect exhaust duct to exhaust hood. Use duct tape to seal all joints in exhaust duct. Use caulking compound to seal exterior wall opening around exhaust hood.

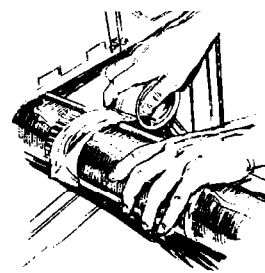

14. Plug the power supply cord into the grounded outlet.

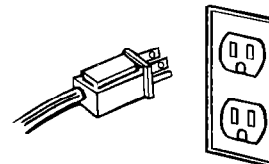

15. Turn the dryer on to remove air from the gas supply line. Using a full heat cycle (not the air cycle), let the dryer run for at least five minutes. If the burner does not ignite and you can feel no heat inside the dryer, shut off the dryer for five minutes. Check that the gas supply line shutoff valve is in "ON" position. Repeat the five-minute test.

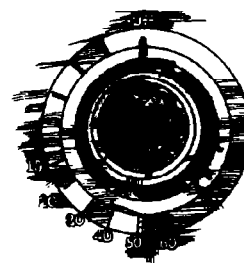

timer control knob

16. Check to see that all of the parts you removed from the installation parts packages in Step 2, Panel C are now installed in the dryer. If you still have an extra part, go back through the steps to see what you skipped.

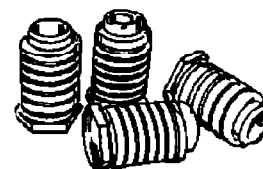

17. Check to make sure you have all the tools you started with in Step A, Panel A.

To get the most efficient use from your new dryer, read your Use and Care Guide. Keep Installation Instructions and Guide close to dryer for easy reference.

Recessed and closet installation instructions

⚠ WARNING

Fire/Health Hazard

- Exhaust the dryer to the outside to prevent exposure to substances in the gas fuels and combustion by-products which may be harmful to your health.
- If dryer is installed in a closet, the dryer **MUST** be exhausted outside.

Failure to do so may result in a fire or health hazard.

The following installation spacings and door air openings for the dryer are possible when installed and exhausted as noted. (Spacing as indicated is in inches and is minimum allowable. For ease of installation and service, additional spacing should be considered.)

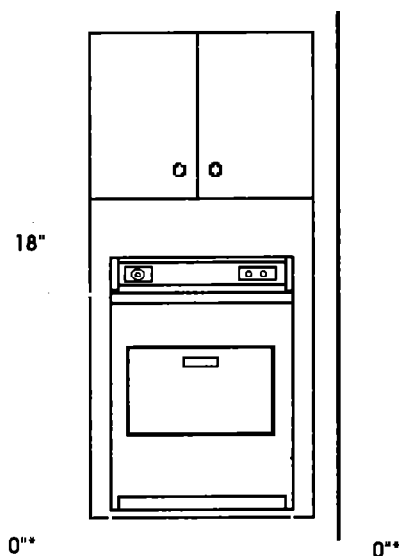

Recessed front view

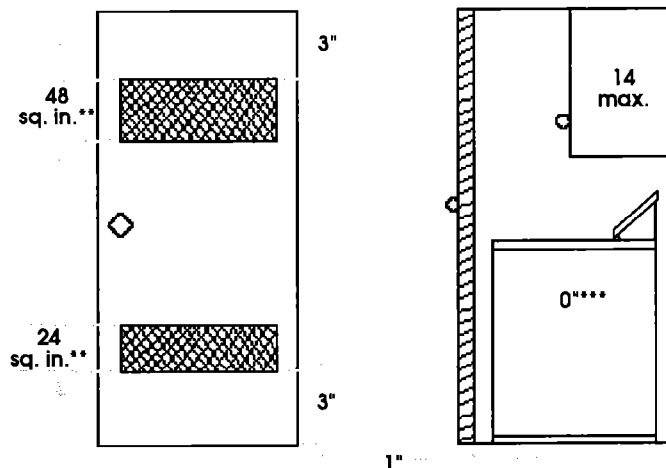

TO PREVENT LARGE AMOUNTS OF LINT AND MOISTURE FROM ACCUMULATING, TO MAINTAIN DRYING EFFICIENCY AND TO PREVENT EXPOSURE TO POSSIBLE HEALTH HAZARDS, THIS MACHINE MUST BE EXHAUSTED OUTDOORS.

- * Additional clearances for wall, door and floor moldings may be required.
- ** Opening is minimum for closet door. Louvered door with equivalent air openings is acceptable.
- *** Additional space is needed when external exhaust elbow is used.

Companion appliance spacings should be considered.

Detailed space requirements can be found on the label located on the back panel of dryer.

NOTE: No other fuel-burning appliance may be installed in the same closet.

If dryer does not operate properly...

If dryer will not operate, check to be sure that:

- Electrical supply is connected.
- The house fuse has not blown or circuit breaker has not tripped.
- Door is closed.
- Controls are set in a running or "ON" position.
- Start button has been pushed firmly.
- Gas supply line shutoff valve is open.

When moving the dryer...

- Disconnect the power supply cord and tape securely to dryer.
- Shut off the gas supply valve controls in the gas supply line.
- Disconnect gas pipe fittings from dryer and cap the gas supply line.
- Tape the drum to the front panel. Tape the dryer door, lint screen lid and end of dryer gas pipe.
- Turn leveling legs all the way in.

Before installing your dryer in your new home, check with your gas supplier or dealer to see that your dryer is equipped with the correct burner for the particular type of gas in your new home. Burner information may be found on the rating plate in the door well of the dryer.

If you need assistance...

Check your Use and Care Guide for a toll-free number to call or call the dealer from whom you purchased this appliance. The dealer is listed in the Yellow Pages of your phone directory under "Appliances - Major". When you call, you will need the dryer model number and serial number. Both numbers are on the serial/rating plate located in the door well behind dryer door and on front of opening.